



# UNI-EL A/S

Dybdalvej 4, Rimmerhus

6920 Videbæk, Denmark

Tel: +45 9716 6311 Fax: +45 9716 6366

Web: www.uni-el.dk Mail : uni-el@uni-el.dk

## PAUL A. JENSEN ApS

# STEUERUNG FÜR 11kW COOL MASTER

## Mit JDI-22 & JDU-210



Kunde : PAUL A. JENSEN ApS - Maschinfabrik - Hærvejen 135 - 6230 Rødekro - Denmark - Tel +45 74666588 - Fax +45 74665186 - Web: www.paj-aps.com

Schluss kunde :



Kunde : PAUL A. JENSEN ApS - Maschinfabrik - Hærvejen 135 - 6230 Rødekro - Denmark - Tel +45 74666588 - Fax +45 74665186 - Web: www.paj-aps.com

Projekt : STEUERUNG FÜR 18,5kW COOL MASTER m/ JDI22 & JDU-210 Instr.

PS:Dieses Dokument ist vertraulich und das Urheberrecht und Warenzeichen sind gesetzlich geschützt. Es darf ohne unsere schriftliche Genehmigung nicht an dritte Personen weitergegeben werden.

Gründen : 18-06-2002

Abändern : 25-11-2011

Revision : V03-01

Archiv Nr : 3-163-040

Ware Nr : 040.PAJ

Konstrukteur : KB

← Vorig :

→ Nächste: 2

# Inhaltsverzeichnis

Seite Nummer	Seite titel	Seite Nummer	Seite titel
3	EU Incorporation Declaration		
4	Wires - Marking, Colours and Signal Symbols		
5	Schrankansicht / Schrank Lay-out		
6	Elektrisch Nachweis		
7	Elektrisch Nachweis		
8	Klemmleiste Übersicht		
9	Verbindungskasten		
10	Stück Liste		
11	Komponente Liste		



## EU INKORPORERINGSERKLÆRING FOR DELMASKINE MASKINDIREKTIVETS BILAG II B.

Produkt: STEUERUNG FÜR 18,5kW COOL MASTER m/ JDI22 & JDU-210 Instr.  
Fabrikeret af: Uni-El AS  
Dybdalvej 4 - Rimmerhus  
6920 Videbæk - Denmark  
Model/Type: 040.PAJ / 3-163-040 Produktions år: 25-11-2011

Undertegnede erklærer hermed at delmaskinen er fremstillet i overensstemmelse med de væsentlige sundheds- og sikkerhedskrav i maskindirektivet 2006/42/EF.

Delmaskinen skal inkorporeres og/eller samles med andre dele omfattet af maskindirektivet af 17. maj 2006 (2006/42/EF) med senere ændringer - svarende til Arbejdstilsynets bekendtgørelse 561/94, Kapitel 2

– og opfylder derfor ikke i den aktuelle udførelse bestemmelserne i Maskindirektivet i alle henseender.

Delmaskinen er i overensstemmelse EU-direktiverne 2006/95/EF (Lavspændingsdirektivet) og 2004/108/EF (EMC-direktivet) – sidste nævnte kun når der ikke er tale om en fast installation.

Delmaskinen er fremstillet i overensstemmelse med følgende harmoniserede standarder med relation mod Maskindirektivets bilag I:

- EN 60 204-1: Elektrisk materiel på maskiner.
- EN ISO 13850: Nødstop
- EN ISO 13849: Sikkerhedsrelaterede dele af styringssystemer

Disse standarder er kun anvendt i det omfang det er relevant i forbindelse med koblingsanlæggets individuelle udførelse.

Andre harmoniserede og internationale standarder er fulgt, når dette er krævet ifølge de ovenfor med nummer refererede standarder.

Der erklæres forbud mod ibrugtagning, indtil den færdige maskine/installation, hvori ovennævnte produkt inkorporeres, som en helhed er erklæret i overensstemmelse med alle relevante bestemmelser i Maskindirektivet (2006/42/EF med senere ændringer)

- og andre relevante direktiver og dette er bekræftet af maskinens overensstemmelseserklæring, samt ved CE-mærkning mindst relaterende mod Maskin- og Lavspændingsdirektivet.

Sted og dato Rimmerhus, den: 25-11-2011

Ansvarlig Underskriver



## EU INCORPORATION DECLARATION FOR PART-MACHINE MACHINE DIRECTIVE ENCLOSURE II B.

Product: STEUERUNG FÜR 18,5kW COOL MASTER m/ JDI22 & JDU-210 Instr.  
Manufacturer: Uni-El AS  
Dybdalvej 4 - Rimmerhus  
6920 Videbæk - Denmark  
Model/Type: 040.PAJ / 3-163-040 Production year: 25-11-2011

It is hereby declared that the Part-machine is made in accordance to the essential health- and safety demands in the Machine Directive 2006/42/EF.

The Part-machines is exclusively designed to have a coherent control function with the entire machine/ installation. It must therefore be incorporated with and/or be connected to other parts encompassed by the machine directive of 17. May 2006 (2006/42/E

Therefore in its present state it does not fulfill actual performance provisions in the Machine Directive in every respect.

The Part-machine is in accordance with the EU-directives 2006/95/EF (Low Voltage directive) and 2004/108/EF (EMC-directive) – the latter only when it is not a permanent installation.

The Part-machine is made in accordance to the following harmonized standards with relation to the Machine directive enclosure I

- EN 60 204-1: Electrical materiel on machinery
- EN ISO 13850: Emergency Shutdown
- EN ISO 13849: Safety related parts of the control systems

These standards are only used to the extent it is relevant in connection with the part-machines individual performance.

Other harmonized and international standards are complied with when this is required according to the above referenced standards.









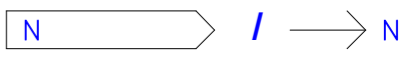

Use of the above mentioned Part-machine is forbidden until the machine/installation in which it is incorporated is general declared in agreement with all relevant decisions in the Machine Directive (2006/42/EF with later changes)

This must be confirmed by the Machine/installations declaration Of Conformity, as well as CE marking that minimum corresponds to the Machine and Low Voltage Directives.

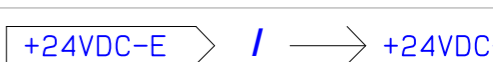
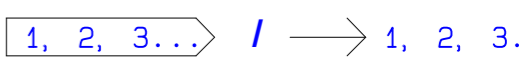
Time and place Denmark - Rimmerhus, Date: 25-11-2011

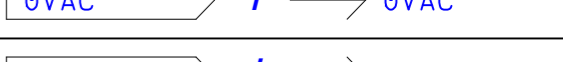
Responsible signer

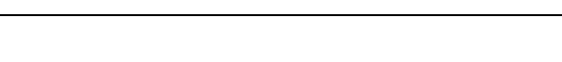
# Wires - Marking, Colours and Signal symbols

Number	Description	Colour	Signalsymbol
000	Neutral wire in main circuits (Before the first transformer)	Light Blue	
001	Phase no 1 in main circuits	Black	
002	Phase no 2 in main circuits	Black	
003	Phase no 3 in main circuits	Black	
004	AC Wire with voltage above 50V - Constant (example with 230VAC)	Red	
005	AC Wire with voltage above 50V - Cut off by Emergency stop (example with 230VAC)	Red	
010, 011, 012...*)	AC Circuits with voltage above 50V	Red	
**)	Neutral wire in AC circuit above 50V	Red w/stribe	
006	+24VDC Wire - Constant	Dark Blue	
007	+24VDC Wire - Cut off by Emergency stop	Dark Blue	
010, 011, 012...*)	+DC circuits	Dark Blue	
**)	-DC circuit	Dark Blue w/stribe	
008	AC Wire with voltage below 50V - Constant (example with 24VAC)	Red	
009	AC Wire with voltage below 50V - Cut off by Emergency stop (example with 24VAC)	Red	
010, 011, 012...*)	AC Circuits below 50V	Red	
**)	Neutral wire in AC circuit below 50V	Red w/stribe	
010, 011, 012...*)	Potential free or External circuits (Foreign Voltage)	Orange	
010, 011, 012...*)	Analog Circuits or circuits with alternating signing	White	
**)	Protection wire (Earth)	Yellow/Green	

\*) PART OF AN AUTOMATIC NUMBERING SYSTEM STARTING FROM NO. 010 (PRECEDING "0"'S ARE NOT MOUNTED ON WIRES)

\*\*\*) NUMBERED BY ITS COLOUR - NUMBER ONLY ASSIGNED IF THERE'S MULTIPLE POTENTIALS WITH THIS COLOUR

SCHRANKANSICHT

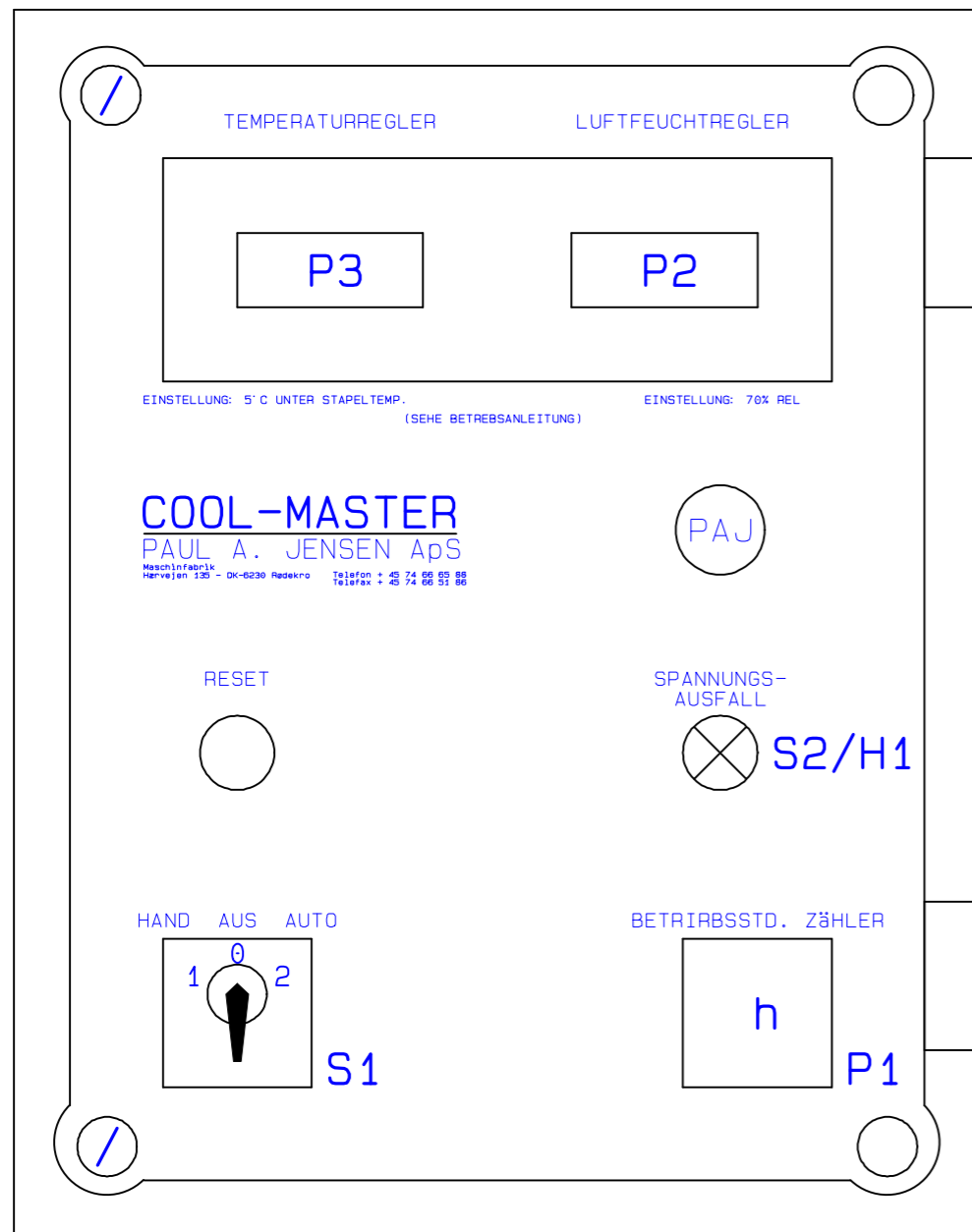

SCHRANK LAY-OUT

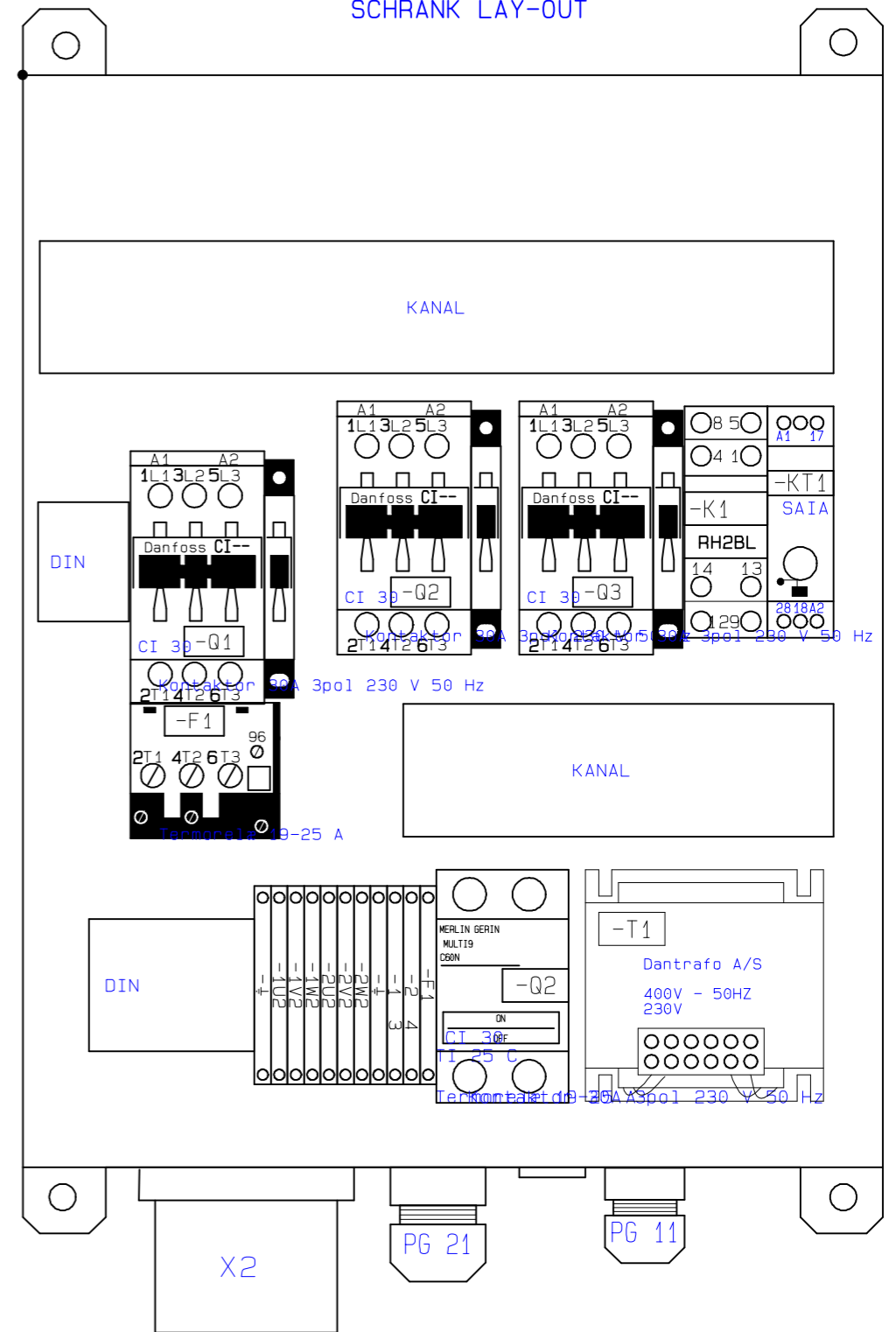

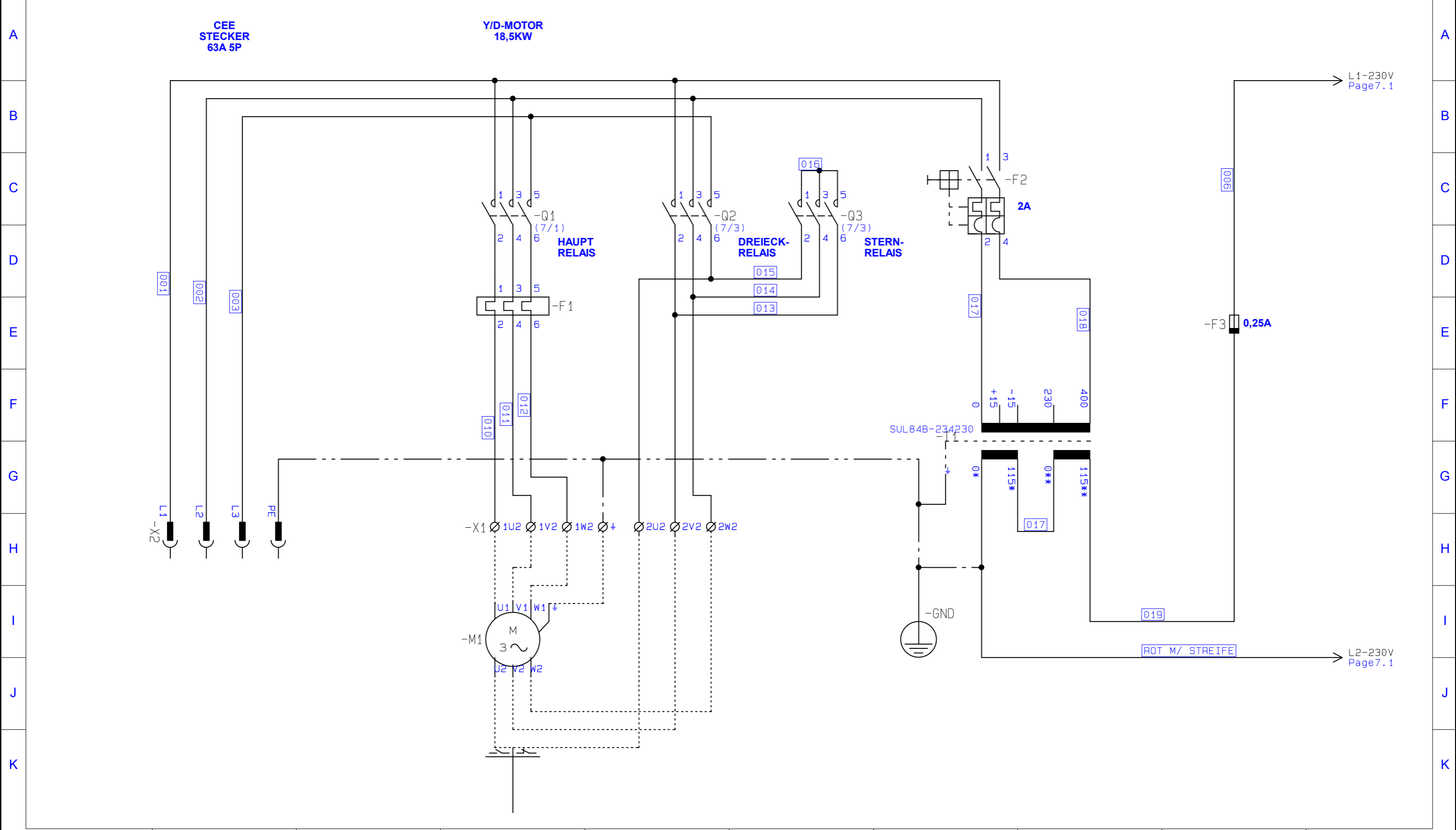

1	2	3	4	5	6	7	8
---	---	---	---	---	---	---	---

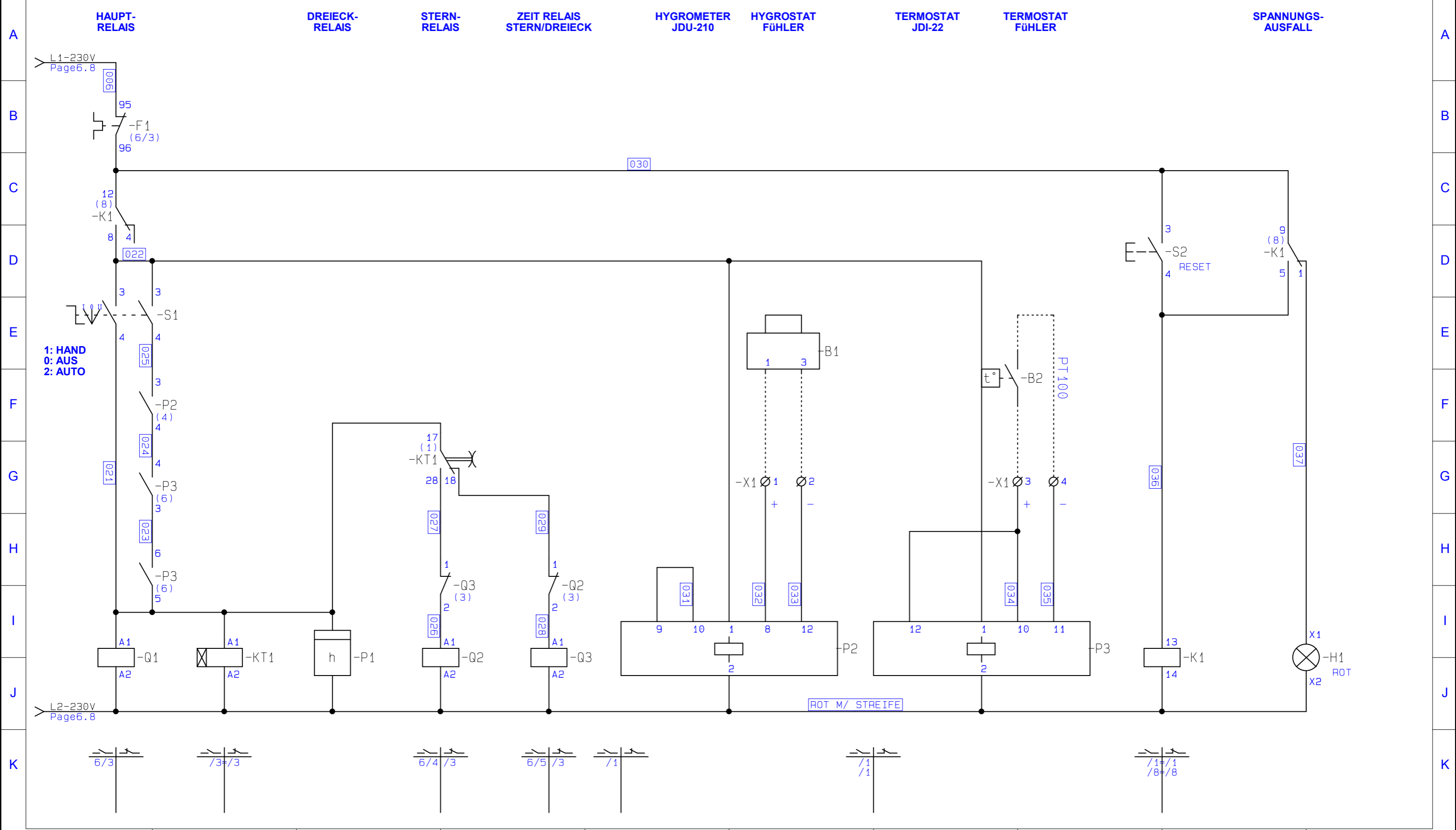

1 2 3 4 5 6 7 8

A

B

C

D

E

F

G

H

I

J

K

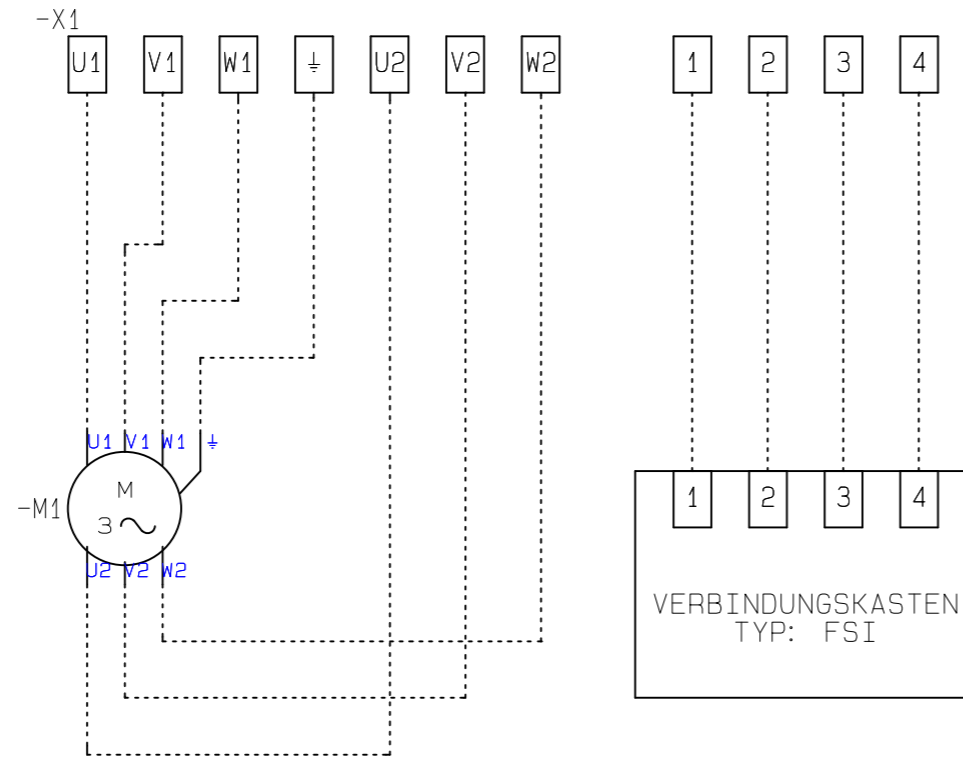

A

B

C

D

E

F

G

H

I

J

K

1

2

3

4

5

6

7

8



A

B

C

D

E

F

G

H

I

J

K

## VERBINDUNGSKASTEN

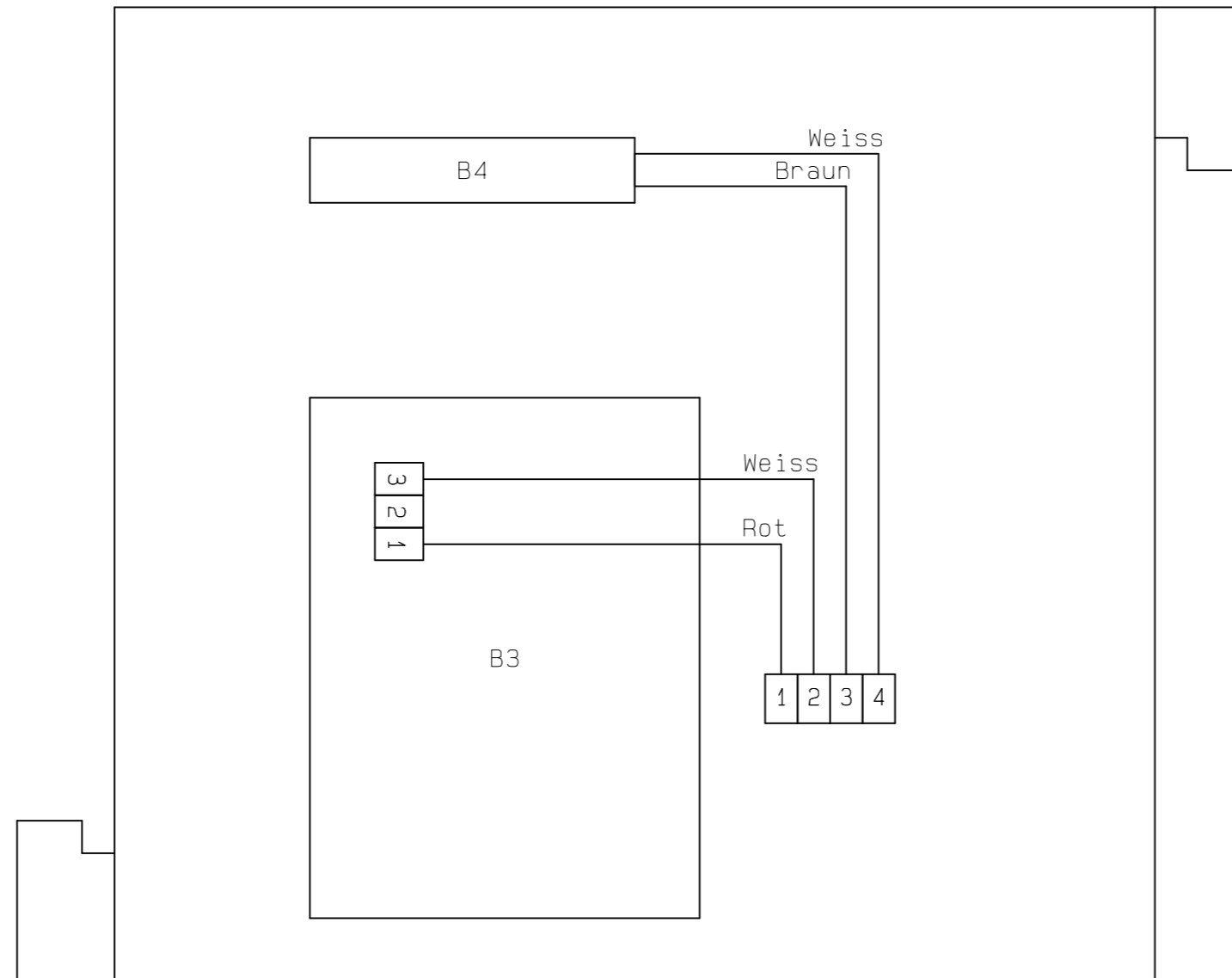

A

B

C

D

E

F

G

H

I

J

K

1

2

3

4

5

6

7

8

# Stück Liste

Ware nr	Beschreibung (Deutsch)	Beschreibung (Dänisch)	Typ	Menge
4-065-084231	Transformer 230/400V (+/-15) => 115V-2*50VA / 230V-100VA	Transformer 230/400V (+/-15) => 115V	SUL84B-234230	1
2322023022	Hilfskontakt 1 Offner	Hjælpekontakt 1 B	CB-NC	2
2322024940	Thermorelais 19-25 A	Termorelæ 19-25 A	TI 25 C	1
2322046517	Schütze 30A 3 Hauptkontakte 230 V 50 Hz	Kontaktor 30A 3pol 230 V 50 Hz	CI 30	3
3322243322	Automatisch Sicherung C60N 2P 2A C-Kurve	Automatsikring C60N 2P 2A, C-kurve	24332	1
5423501013	Paladin Stundenzähler 230V 50Hz Frontmontiert	Paladin timetæller 230V 50HZ f. tavl	BW 40.18	1
5740470530	Doppelklemme 4mm <sup>2</sup>	Rækkeklemme 4mm <sup>2</sup> Dobbelt klemme	WK 4E/U	2
5750400530	Klemme 4mm <sup>2</sup>	Rækkeklemme 4mm <sup>2</sup>	WK 4/U	6
5750490530	Erdungsklemme 4mm <sup>2</sup>	Rækkeklemme 4mm <sup>2</sup> Jordklemme	WK 4 SL/U	1
5790453530	Sicherungsklemme für 5x20mm sicherung	Klemme sikringsholder for 5x20mm sik	WK 4/THSI 5U	1
7517800136	Drehschalter, Komplett, 3 pos, Länge Griff, 2NO	Drejeafb. 3 still., langt greb, 2NO	XB4BJ33	1
7517800741	Druckknopf mit Licht, Rot, 230-240VAC, mit LED	LAMPETRYK RØD 230-240VAC M/LED	XB4BW34M5	2
7517809218	Schild Halter für 18x27mm, Tesys ZB4	SKILTEHOLD.F/SKILT 18X27 F/ZB4	ZBZ33	3
7517809506	Schild Swartz/Rot 18x27mm keine schrift	Skilt Sort/Rød 18x27mm u/ tekst	ZBY5101	3
5703436004288		Relæsokkel f/DIN-m.berø.SI	SH2B-05C	1
5703436005070	Relais 2polig 10A mit LED	Relæ 2pol.10Amp m/lys	RH2BL-AC-230V	1
-	Nicht von Uni-El A/S Geliefert	Ikke lev. af UNI-EL A/S	Ikke lev. af UNI-EL A/S	5
KOP 251	Stern/Dreieck Timer	Y/D TIMER	Y/D TIMER	1

# Komponenten Liste

Nahm	Seite	Beschreibung (Deutsch)	Beschreibung (Dänisch)	Type	Waren nr	Fabrikat
-B1	7/5	Nicht von Uni-El A/S Geliefert	Ikke lev. af UNI-EL A/S	Ikke lev. af UNI-EL	-	-
-B2	7/7	Nicht von Uni-El A/S Geliefert	Ikke lev. af UNI-EL A/S	Ikke lev. af UNI-EL	-	-
-F1	6/3	Thermorelais 19-25 A	Termorelæ 19-25 A	TI 25 C	2322024940	DANFOSS A/S
-F2	6/6	Automatisch Sicherung C60N 2P 2A C-Kurve	Automatsikring C60N 2P 2A, C-kurve	24332	3322243322	MERLIN GERIN
-F3	6/8	Sicherungsklemme für 5x20mm sicherung	Klemme sikringsholder for 5x20mm sik	WK 4/THSI 5U	5790453530	Wieland Elect
-H1	7/8	Druckknopf mit Licht, Rot, 230-240VAC, mit LED	LAMPETRYK RØD 230-240VAC M/LED	XB4BW34M5	7517800741	TELEMECANIQUE
-H1		Schild Halter für 18x27mm, Tesys ZB4	SKILTEHOLD.F/SKILT 18X27 F/ZB4	ZBZ33	7517809218	TELEMECANIQUE
-H1		Schild Swartz/Rot 18x27mm keine schrift	Skilt Sort/Rød 18x27mm u/ tekst	ZBY5101	7517809506	Telemecanique
-K1			Relæsokkel f/DIN-m.berø.SI	SH2B-05C	5703436004288	IDEC IZUMI
-K1	7/8	Relais 2polig 10A mit LED	Relæ 2pol.10Amp m/lys	RH2BL-AC-230V	5703436005070	IDEC IZUMI
-KT1	7/1	Stern/Dreieck Timer	Y/D TIMER	KOP251	KOP 251	SAIA
-M1	6/3	Nicht von Uni-El A/S Geliefert	Ikke lev. af UNI-EL A/S	Ikke lev. af UNI-EL	-	-
-P1	7/2	Paladin Stundenzähler 230V 50Hz Frontmontiert	Paladin timetæller 230V 50HZ f. tavl	BW 40.18	5423501013	PALADIN
-P2	7/4	Nicht von Uni-El A/S Geliefert	Ikke lev. af UNI-EL A/S	Ikke lev. af UNI-EL	-	-
-P3	7/6	Nicht von Uni-El A/S Geliefert	Ikke lev. af UNI-EL A/S	Ikke lev. af UNI-EL	-	-
-Q1	7/1	Schütze 30A 3 Hauptkontakte 230 V 50 Hz	Kontaktor 30A 3pol 230 V 50 Hz	CI 30	2322046517	DANFOSS A/S
-Q2	7/3	Hilfskontakt 1 Offner	Hjælpekontakt 1 B	CB-NC	2322023022	DANFOSS A/S
-Q2	7/3	Schütze 30A 3 Hauptkontakte 230 V 50 Hz	Kontaktor 30A 3pol 230 V 50 Hz	CI 30	2322046517	DANFOSS A/S
-Q3	7/3	Hilfskontakt 1 Offner	Hjælpekontakt 1 B	CB-NC	2322023022	DANFOSS A/S
-Q3	7/3	Schütze 30A 3 Hauptkontakte 230 V 50 Hz	Kontaktor 30A 3pol 230 V 50 Hz	CI 30	2322046517	DANFOSS A/S
-S1	7/1	Drehschalter, Komplett, 3 pos, Länge Griff, 2NO	Drejeafb. 3 still., langt greb, 2NO	XB4BJ33	7517800136	Telemecanique
-S1		Schild Halter für 18x27mm, Tesys ZB4	SKILTEHOLD.F/SKILT 18X27 F/ZB4	ZBZ33	7517809218	TELEMECANIQUE
-S1		Schild Swartz/Rot 18x27mm keine schrift	Skilt Sort/Rød 18x27mm u/ tekst	ZBY5101	7517809506	Telemecanique
-S2	7/8	Druckknopf mit Licht, Rot, 230-240VAC, mit LED	LAMPETRYK RØD 230-240VAC M/LED	XB4BW34M5	7517800741	TELEMECANIQUE
-S2		Schild Halter für 18x27mm, Tesys ZB4	SKILTEHOLD.F/SKILT 18X27 F/ZB4	ZBZ33	7517809218	TELEMECANIQUE
-S2		Schild Swartz/Rot 18x27mm keine schrift	Skilt Sort/Rød 18x27mm u/ tekst	ZBY5101	7517809506	Telemecanique
-T1	6/6	Transformer 230/400V (+/-15) => 115V-2*50VA / 230V-100V	Transformer 230/400V (+/-15) => 115V	SUL84B-234230	4-065-084231	NORATEL LÜBCK
-X1	7/5	Doppeltklemme 4mm <sup>2</sup>	Rækkeklemme 4mm <sup>2</sup> Dobbelt klemme	WK 4E/U	5740470530	Wieland Elect
-X1	6/4	Klemme 4mm <sup>2</sup>	Rækkeklemme 4mm <sup>2</sup>	WK 4/U	5750400530	Wieland Elect

